

Photochemical cross-linking study of polymers containing diacetylene groups in their main chain and azobenzene compounds as pendant groups

E. Viguera-Santiago, S. Hernández-López* and A. Rodríguez-Romero

*Laboratorio de Investigación y Desarrollo de Materiales Avanzados, Facultad de Química, UAEM
Paseo Colón esquina con Paseo Tollocan sin número, C.P. 50000, Toluca, Estado de México. México*

Photochemical cross-linking studies at different temperatures (room temperature, T_g and maximum exothermal of cross-linking peak) are shown for three series of polymers containing diacetylene-groups in the main chain and polar chromophores derived from benzene, azo- and di-azobenzene, as pendant groups. We establish the optimal irradiation time and temperature that permit them being poled and cross-linked with minimal dye-degradation. The degradation process was followed by a diminution of the respective maximum absorption peak. These conditions could extend the mean life-time of the second order nonlinear optical properties, studied previously. Photochemical cross-linking at each polymer's T_g (50-130°C) was the most convenient process. It took less than 10 min and was monitored by IR spectroscopy.

Keywords: Diacetylene; Cross-linking; Photodegradation

1. Introduction

The study of polymers with second order nonlinear optical properties (2-NLO) has been focused to try of maintaining indefinitely the polar order imposed to the optically active units (chromophores) that constitute a polymeric structure [1,2]. Polymers poled have the problem that the optically active molecules return to their random state (relaxation effect) and their 2-NLO activities fade away [3,4] with time and temperature. This effect has been attributed to polymeric compounds of having practical applications in technological devices, even though other qualities are optimal such as their physical and thermal resistance, processing and large optical activity. One of the most used strategies during the last 15 years, but without achieving yet the planned goal, is cross-link the polymers [5, 6] for reducing both: the free volume around optically active molecules (and therefore their rotational movements) and the movements of the main chains. These parameters are considered as the fundamental origin of gradual lost for orientation and 2-ONL activities [7, 8].

In order to diminish both: segmental chains movement and free volume around chromophores, materials with inherent properties for cross-linking should be produced. S. Hernández and T. Ogawa [9-12] studied diacetylene-containing polymers in their main chains (with different chemical structure) for that purpose. They synthesized a main chain [10, 13] that allowed to chromophores a very good parallel arrangement. These compounds had high second order nonlinear coefficients: d_{33} from 250 to 360 pm/V and high order parameters: S , between 0.4 and 0.6 [12, 13]. The main chain contains diacetylene (DA) groups which could thermal- or photo-chemically cross-linked in solid state [14, 16] (Fig. 1). These alternatives could permit to reduce the relaxation effect in 100%. However, they observed that cross-linking temperature (evaluated by DSC) is too high in relation to each polymer's glass transition temperature (T_g). Cross-link them at high temperature already orientated would not be possible, due

to chromophores' orientation [14] would be lost. An alternative to this problem consists in cross-link them photochemically, whether at room temperature immediately after poling process, or at T_g but simultaneously to the poling process. From UV/Vis spectroscopy preliminary studies [17], they observed that induced-ultraviolet radiation cross-linking process, renders very stable thermally films but also a photodegradation effect on azo-chromophores groups. This secondary reaction [6, 17] depends on the exposition time and is feasible to be avoided if appropriate conditions are studied. A systematic spectroscopic study of photo cross-linking behaviour in DA- and chromophore-groups [8] containing polymers was performed and the results are discussed here.

2. Experimental details

The polymers studied were synthesised and characterised previously [10,11]. Their chemical structures are showed in Figure 2, and their thermal and polar orientation characterizations are shown in Table 1. Polymers gave films with excellent optical quality by spin coating their solutions (in chloroform or N,N-dimethyl-formamide (DMF) on glass and KBr-plates substrates).

2.1. Equipment and general methodology

2.1.1. For studies at T_g and cross-linking maximum temperature, a calibrated heating plate was available.

2.1.2. For ultraviolet irradiation of polymers, we have a low density mercury lamp that emits in the ultraviolet region with a maximum energy at 254 nm (8 W lamp delivery power; 54 mJ/cm² Uv irradiance on films). For continuous expositions to Uv radiation (more than 10 min) a quartz cooling-water system was used. Distance of the films polymers from the lamp was 10 cm in all experiments.

*shernan@uamex.mx

Table 1. Thermal properties of polymers and poling temperature

Polymer	T _g (°C) ¹	T _{i-ret} (°C) ²	T _{ret} (°C) ³	T ₅ (°C) ⁴	T _{poling} (°C) ⁵
P-PB	30.0	130.0	183.4	238	48
P-mB	87.0	175.0	220.0	300	-
P-pB	103.5	170.0	221.0	277	122
P-PA _{NO2}	103.5	-	-	279	-
P-mA _{NO2}	85.0	162.0	187.0	262	-
P-pA _{NO2}	106.0	160.0	204.0	269	113
P-PA _{CN}	110.0	177.0	186.0	265	-
P-mA _{CN}	50.0	162.0	180.3	253	69
P-pA _{CN}	110.0	170.0	189.0	246	121
P-PDA _{NO2}	113.0	150.0	207.8	262	-
P-mDA _{NO2}	104.0	160.0	197.5	265	-
P-pDA _{NO2}	122.0	152.0	181.0	262	138
P-PDA _{CN}	84.5	155.0	181.0	270	85
P-mDA _{CN}	63.0	170.0	236.0	270	-
P-pDA _{CN}	120.0	150.0	180.0	266	127

¹ T_g = Glass transition temperature (DSC: 10°C/min, N₂)

² T_{i-ret} = Cross-linking start temperature of DA-units

³ T_{ret} = Maximum temperature of cross-linking's exotherm

⁴ T₅ = Temperature at that the polymer loses 5 of its weight and begins to degrade

⁵ T_{pol} = Temperature of poling process (some degrees higher than T_g)

2.1.3. For the cross-linking monitoring, an IR Spectrophotometer, Nicolet FT-IR 510 and a Nicolet IR-TF 510p spectrophotometer were used. The diminution of the band corresponding to the functional diacetylene group (-C≡C-C≡C-) around 2200-2250 cm⁻¹ was monitored. Total disappearing of that signal means that cross-linking reaction took place. Another parameter for monitoring the cross-link process was the films' solubility in chloroform and N,N-dimethyl-formamide (DMF). In these solvents, uncross-linked polymers were highly soluble. According to the cross-linking degree, this solubility decreased until films were completely insoluble.

2.1.4. For photodegradation, a Uv/vis (190-900 nm) Shimadzu 160A spectrophotometer was employed. Different exposition times to radiation and temperature were taken for each polymer. Degradation analyses were registered as a diminution of the absorption peak corresponding to azo-and diazo-chromophores.

2.2. Thin film preparation

Polymer films were prepared by spin coating technique. Saturated polymeric solutions (20 mg/ml) in chloroform or DMF were prepared and deposited on KBr plates (diameter 0.5 cm and thickness 0.3 cm) for following the Uv/vis-degradation, or glass substrates (2.0 X 2.5 X 0.2 cm) previously cleaned and dried for monitoring cross-linking reaction by IR spectroscopy. The spinning velocity was 1,500 rpm for one minute. Afterwards, the films were vacuum dried for 4 hours.

3. Results and discussion

3.1. Photodegradation and photocross-linking at room temperature

For photodegradation study, polymer films on glass substrates were characterized primarily by Uv/Visible spectroscopy (reference films). Immediately, they were irradiated at intervals of 5-15 min and a Uv/vis spectrum was run after each one. Photodegradation was observed by a diminution of their absorption peak. In this study, the polymers were exposed for long times to Uv irradiation (more than 60 min) but radiation did not have a cross-linking effect under these conditions. However, *trans-cis* photo-isomerisation was made present as well as degradation that took place from 60 min of exposition to radiation.

In Figure 3, is shown an example of photo-degradation monitored for P-pA_{CN} polymer until 180 min of irradiation time, performing solubility tests and determining the IR spectra every 30 min. At 210 min it degraded completely, without achieving cross-linking. The *trans-cis* isomerisation was detected when the absorption peak (290 nm) grew at expenses of the higher wavelength absorption band (430 nm). This higher absorption corresponds to the *trans* isomeric structure. *Trans-cis* isomerization is reversible after few minutes of stopping the Uv-irradiation or instantly if the film is heated at its corresponding T_g or higher. The polymeric film lost its original properties of colour and transparency, without changing its solubility when it started to degrade.

Table 2. Results of the polymer films' photoirradiationⁱ at their corresponding T_g.

Polymer	T _g (°C) ¹	t _{cri} ² (min)	degradation ³ %	t _{full_deg} ⁴ (min)
P-PB	56.0	2		90
P-mB	87.0	7	0	60
P-pB	103.5	5		60
P-mA _{NO2}	85.0	7	6-7	30
P-pA _{NO2}	106.0	5		40
P-PA _{CN}	110.0	2	3	45
P-pA _{CN}	110.0	4	5	37
P-PDA _{NO2}	113.0	2	4	44
P-mDA _{NO2}	104.0	5	9	28
P-pDA _{NO2}	122.0	4	9	31
P-PDA _{CN}	84.5	2	3	40
P-pDA _{CN}	120.0	4	6	20

ⁱ The distance from the Uv lamp to samples was 10 cm.

¹ Glass transition temperature, determined by DSC (10°/min, N₂)

² Cross-linking time

³ % of degradation at cross-linking time

⁴ Time at which polymers degrade completely

The explanation that no photo cross-linking reaction took place under room temperature, is due to diacetylene groups inserted into the main chains do not have the minimum distance necessary to do it (4Å or less) [13, 14]. Approaching of the DA-groups under environmental conditions is avoided by the presence of the voluminous aromatic groups into the main chain. However, main chains and pendant groups possess enough rotation and vibration movements in order to DA- groups have eventual approaches [13, 14] for reacting at T_g.

An IR spectrum of the same P-pA_{CN} polymer film before and after 60 min of irradiation is shown in Figure 4. There is no transmittance diminution for the irradiated film, in comparison with the no irradiated sample. This fact indicates that there is no cross-linking between diacetylene groups. Another evidence for no cross-linking, was the high solubility of the polymer films in chloroform and DMF.

3.2. Photodegradation and cross-linking study at glass transition temperature

For photodegradation study, in the same way as in the previous case, polymer films deposited on glass substrates

(reference films) were characterised by Uv/visible spectroscopy. Afterwards, they were irradiated at intervals of 5 min at their respective T_g temperature (Table 1). A graduated heating plate was used for these experiments. Characterization was newly performed and compared with the reference sample's spectrum after each exposition cycle, until complete degradation was detected. Degradation was considered as the total disappearance of the dye absorption peak (Fig. 5 and Fig. 6). After recognising the time in which dye begins to degrade, a cross-linking study was made by IR spectroscopy with polymer samples deposited on KBr disks. For this, a polymer reference spectrum was taken (without any treatment) first. After, it was exposed to a Uv lamp for ranges of 2 min (or less) and a new spectrum was taken and compared with the first one. In the same way, solubility tests were performed at these times. These cycles permitted to detect the evolution of cross-linking before the degradation process started (Fig. 7).

Cross-linking times, percent of degradation at cross-linking time and total degradation time are presented in Table 2. Cross-linking results were confirmed by solubility tests. Polymer films were losing solubility according to their cross-linking degree, until being completely insoluble

Table 3. Photochemical cross-linking at maximum exothermal for cross-linking of some polymers.

Polymer	Cross-linking temperature (°C)	Cross-linking time (min)	Time at that photo degradation started (min)
P-PA _{CN}	177	2.30	4.30
P-mA _{NO2}	162	2.35	4.35
P-PDA _{NO2}	150	0.20	0.45
P-mDA _{NO2}	160	0.30	2.30

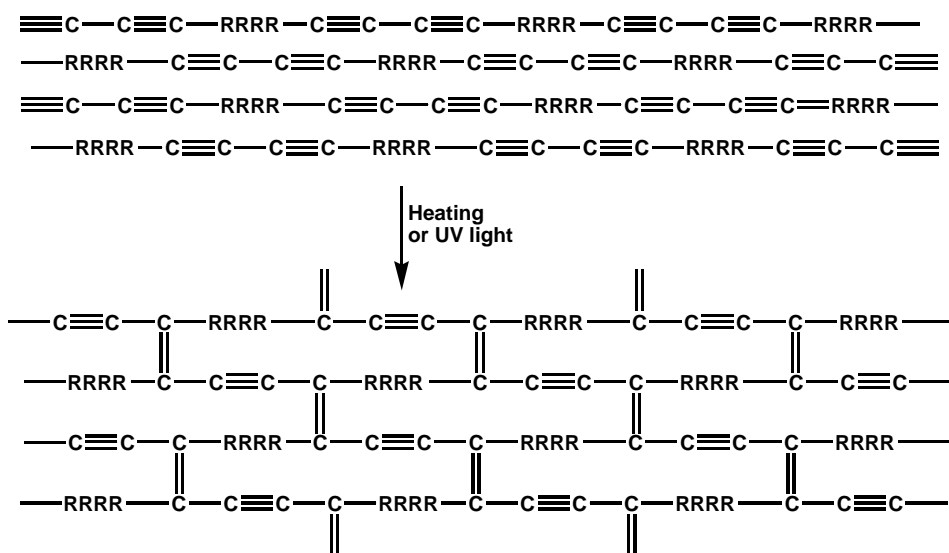

Figure 1. Ideal solid state cross-linking reaction among polymer chains containing cross-linkable DA-units.

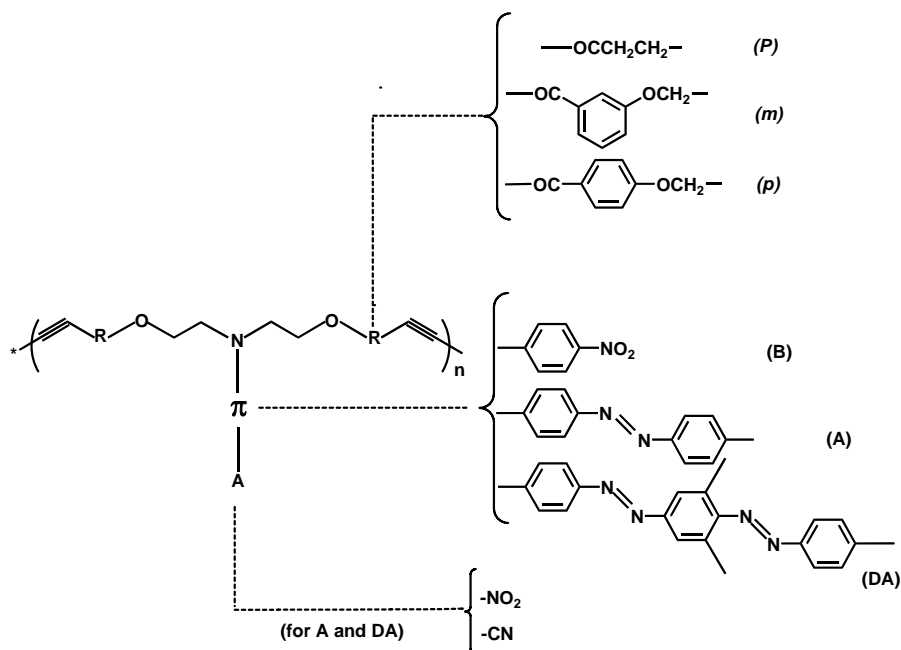

Figure 2. Organic blocks that constitute polymers with a diacetylene group in the main chain and with chromophore as pendant compounds. Italic letters (*P, m and p*) are used for referring *pentinoic*, *m-propargiloxibenzoic*- and *p-propargiloxibenzoic* segments, respectively used for synthesizing main chain polymers. Letters **B**, **A** and **DA** are used for identifying π -system of chromophores compounds: benzene-, azobenzene, and di-azobenzene, respectively. Two last (**A** and **DA**) could have a nitro- or nitrile as acceptor groups. Abbreviation for each polymer is made by a combination of that letters: **P-PA_{NO₂}** P- meaning “polymer”, *P* referring to “pentinoic” group in main chain and the full chromophore **A_{NO₂}** consists on an “azo”derivated containing a nitro group.

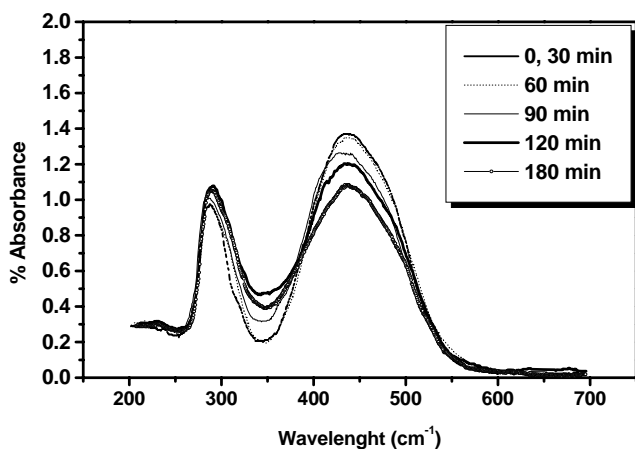

Figure 3. Uv/vis degradation curves of a P-pA_{CN} polymer film taken every 30 min.

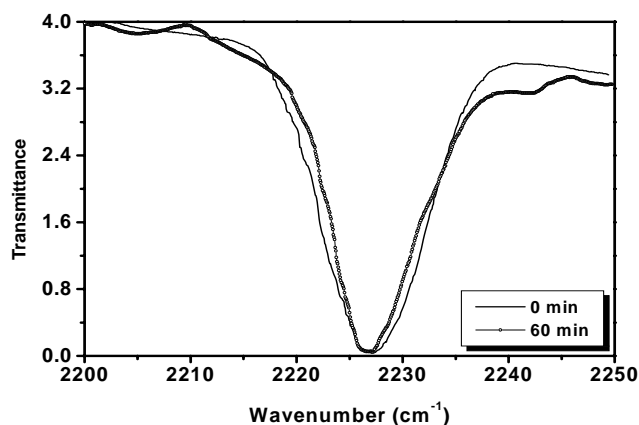

Figure 4. IR spectrum of the polymer P-pA_{CN}: two practically equal signals are at 2225 cm⁻¹ showing that diacetylene groups (-C≡C-C≡C-) does not suffer photo cross-linking at environmental temperature after 60 min of exposition to Uv light.

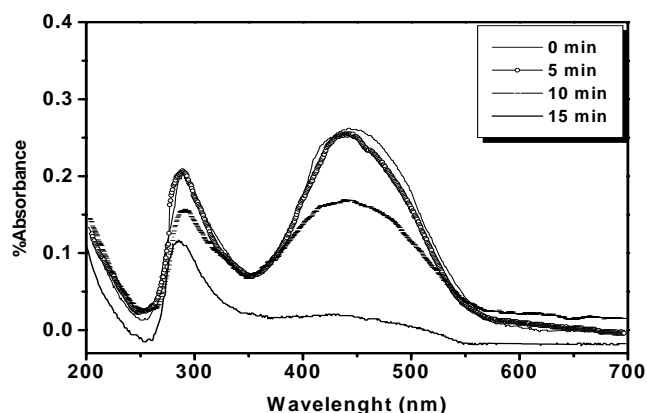

Figure 5. Uv/vis shifting showing the degradation process of P-pA_{CN} polymer.

by soaking it in chloroform and DMF. They were completely insoluble when they reached the maximum degree of cross-linking (observed by IR, Fig. 7).

A generalization including the behaviour of all polymers cannot be done. Polymers containing pentinoic segment, cross-link faster y show a less degradation percent than those containing aromatic groups in main chain. All them cross-linked in seven minutes or less and after 20 min they completely degrade. These results could be attributed to difficult approaches among DA-groups (Fig.1) in polymers containing bulk aromatics groups in main chain, even at Tg [14,15]. These polymers need more time for reacting, but being under ultraviolet exposition they suffer a little more percent of degradation than pentinoic ones. Polymers containing nitrobenzene as pendant group does not show degradation effect because of a higher photo- and thermal stability in comparison with azo- and di-azo-benzene derivatives.

3.3. Cross-linking at maximum exothermal of cross-linking peak and UV radiation for some polymers

These tests were performed to confirm the hypothesis that, even at cross-linking temperature (higher than 180°C) that takes approximately 20 min to overcome completely cross-linked polymers, the presence of ultraviolet light accelerates this effect. Polymers under both: high temperature and ultraviolet radiation decrease considerably the cross-linking time (at only 2 min maximum) and it could reduce the degradation effect too. Due to the speed under this process is carried out; it was not possible to obtain cross-linking kinetics. However, an IR spectrum is presented (Fig.8). P-mA_{NO₂} polymer curve is shown before and after 2 min of irradiation at 162°C (Table 1). Cross-linking is total without any IR signal that indicates the presence of DA-groups. The chemical structure of main chain is evident again on the cross-linking reaction. Polymer containing pentinoic groups cross-link faster than those containing the aromatic groups. Degradation under these conditions is neither so pronounced (less than 2%), as in the case of thermal cross-linking. Despite of the cross-linking is fast and the decomposition minimum at high temperature and Uv radiation, it would not be possible to carry out cross-linking in already orientated polymers. That temperature is enough high to originate an instantaneous loss of the polar orientation imposed to the chromophores. Results of photochemical polymerization performed on some polymers at their maximum cross-linking temperature (Table 1) are shown in Table 3.

4. Conclusions

After studying the exposition effect to ultraviolet radiation at different temperatures of three series of polymers containing diacetylene groups in main chains structured by different groups: pentinoic, *meta*-aromatic and *para*-aromatic, and benzene, azobenzene and diazobenzene compounds as pendant groups, it was determined that the best conditions for cross-linking them

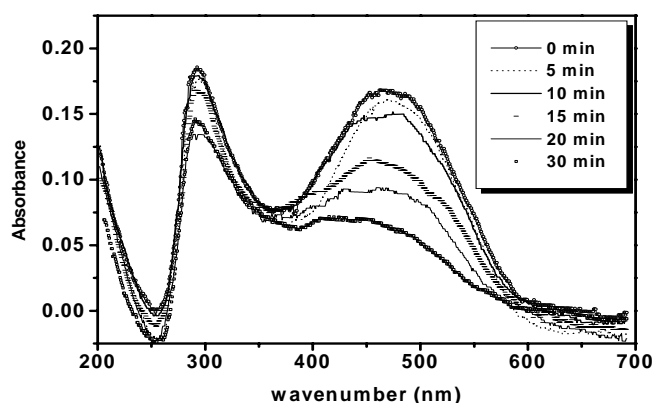

Figure 6. Uv/vis bands showing the degradation process of the P-pA_{NO2} polymer. These curves were taken every 5 min.

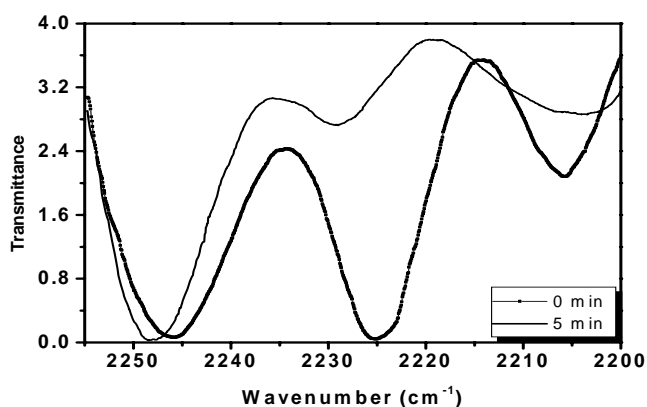

Figure 7. IR spectrum showing cross-linking evolution for P-pA_{NO2} polymer. At 5 min. of UV-exposition it shows a decrease in the signal at 2225 cm⁻¹ (corresponding to DA-groups) and indicating that they are reacting between each other to form a 3-D network.

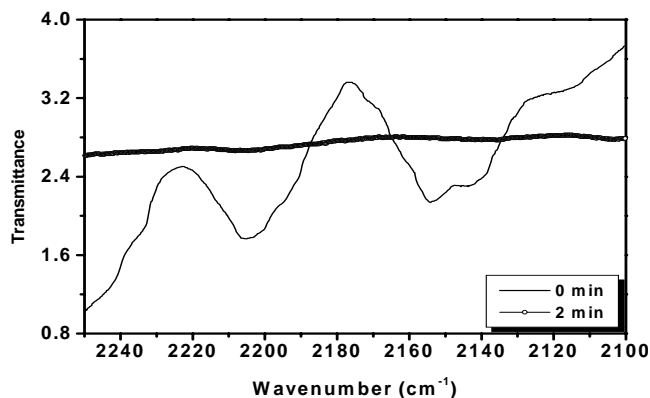

Figure 8. IR spectrum showing the disappearance of DA-groups signals of the P-mA_{NO2} polymer, by photochemical cross-linking effect (at 2 min.) at 187°C.

is at their own T_g. This conditions offer two possibilities for cross-linking the polymers 1) posterior at the polar orientation (poling) process or 2) simultaneously during this. These situations depend on the groups in main chain. For bulk and rigid groups (such aromatic ring) Uv exposition and temperature period must be longer than those for lineal and flexible groups as pentinoic one. In general, cross-linking time is lower than 10 min, dye decomposition is not significant and their non-linear optical properties could not be crucially altered. DA-containing polymers do not fulfil the minimum requirements for approaching and reacting at room temperature. At this condition, only *trans*→*cis* isomerisation and long time degradation were observed. Absorption corresponding to the *cis* isomer (around 350 nm) grew at expenses of the *trans* isomer absorption (around 450 nm). The original spectrum was recovered at some minutes after the ultraviolet light source was quit, or immediately when polymer film was exposed at T_g. Once photodegradation was detected, total polymer degradation was evident and the original spectra were not longer regained.

Acknowledgements

This project was funded by the Universidad Autónoma del Estado de México (UAEM) as project No. 1664/2003. We would like to thank MSc María Magdalena García Fábila (FQ-UAEM), Technician Ruth Georgina Salinas Gómez (FQ-UAEM), ChEn Miguel Ángel Canseco (IIM-UNAM) for his support in the characterization techniques.

References

- [1] S. Miyata and H. Sasabe, Light Wave Manipulation using Organic Nonlinear Optical Materials, Gordon and Breach Science Publishers, Singapore (2000)
- [2] S. Marder, E.J. Sohn and D.G Stucky, Materials for Nonlinear Optics. Chemical Perspectives, ACS Symposium Series 455, Washington DC (1991)
- [3] T.J. Marks and M.A Ratner, Angew. Chem. Int. Ed. Engl., **34**, 155(1995)
- [4] D.L. Wise, G.E. Wnek, D.J. Trantolo, T.M. Cooper and J.D. Gresser, Electrical and Optical Polymers Systems: Fundamentals, Methods and Applications, Marcel Dekker, Inc NY, USA (1998).
- [5] M. Eich, B. Reck, D.J. Yoon, C.G. Wilson and C.G. Bjorklund, J. Appl. Phys., **66**, 3241(1989)
- [6] M. Chen, L. Yu, L.R. Dalton, Y. Shi and W.H. Steier Macromolecules, **24**, 5421(1991)
- [7] H.L. Hampsch., J. Yang, G.K Wong and J.M. Torkelson, Polymer Communication, **30**, 40(1989)
- [8] H.L. Hampsch., J. Young, G.K. Wong and J.M. Torkelson, Macromolecules, **23**, 3640(1990)
- [9] M. Sukawattanasinitt, D-C. Lee, M. Kim, X. Wang, L. Li, K. Yong, J. Kumar, S. Tripathy and D.J. Sandman, Macromolecules, **32**, 7361(1999)
- [10] S. Hernández, M.F. Beristain and T. Ogawa, Designed Monomers and Polymers, **5**, 25(2002)
- [11] S. Hernández, E.A. Castillo and T. Ogawa, Polymer Bulletin, **51**, 333(2004)
- [12] H. Miura and T. Ogawa, Polymer Bulletin, **49**, 103(2002)

- [13] S. Hernández, H. Miura, M.F. Beristain, T. Ogawa, T. Watanabe and S. Miyata, *Macromol. Symp.*, **192**, 123(2003).
- [14] T. Ogawa, *Prog. Polym. Sci.*, **20**, 943(1995).
- [15] T. Ogawa and S. Fomine, *Trends in Polym. Sci.*, **2**, 308(1994).
- [16] S. Fomine and T. Ogawa, *Polymer Journal*, **26**, 95(1994).
- [17] S. Hernández, T. Ogawa, T. Watanabe and S. Miyata, *Mol. Cryst. Liq. Cryst.*, **374**, 503(2002).